

# RÜCKHOLUNGSKONZEPT FÜR EIN GEOLOGISCHES TIEFENLAGER

Neuwis-Huus, Stadel, 5. September 2023

Maurus Alig

**nagra.**

# RÜCKHOLUNGSKONZEPT

---

nagra.

## Arbeitsbericht NAB 21-13

Rückholungskonzept für ein  
geologisches Tiefenlager

November 2022

Nationale Genossenschaft  
für die Lagerung  
radioaktiver Abfälle  
Hardstrasse 73  
Postfach  
5430 Wetztingen  
Telefon 056 437 11 11  
[www.nagra.ch](http://www.nagra.ch)

[www.nagra.ch](http://www.nagra.ch)



Schachtanlage Asse 1967







Quelle: [www.smdk.ch](http://www.smdk.ch)





Quelle: [www.smdk.ch](http://www.smdk.ch)





Quelle: Aargauer Zeitung



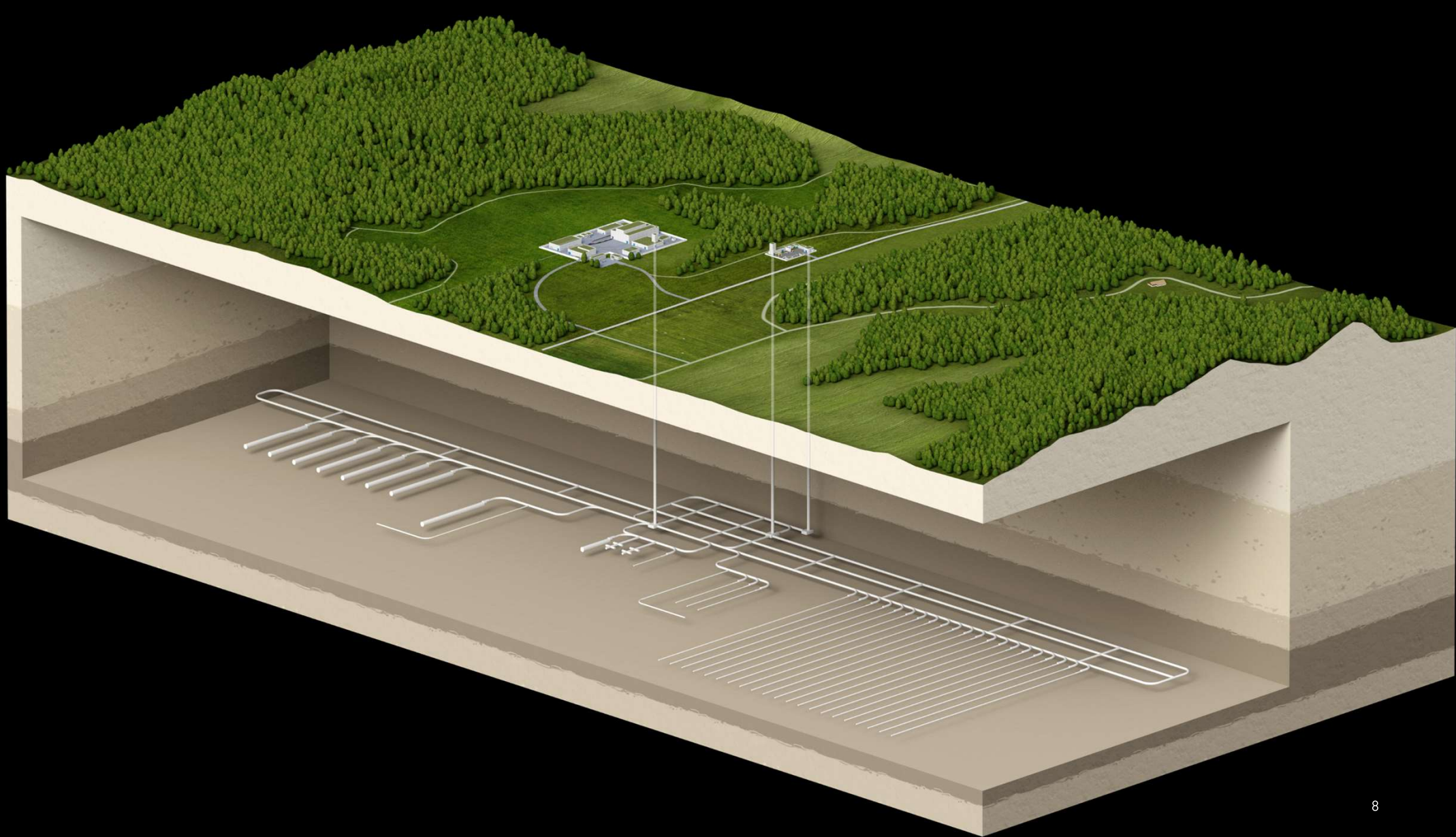



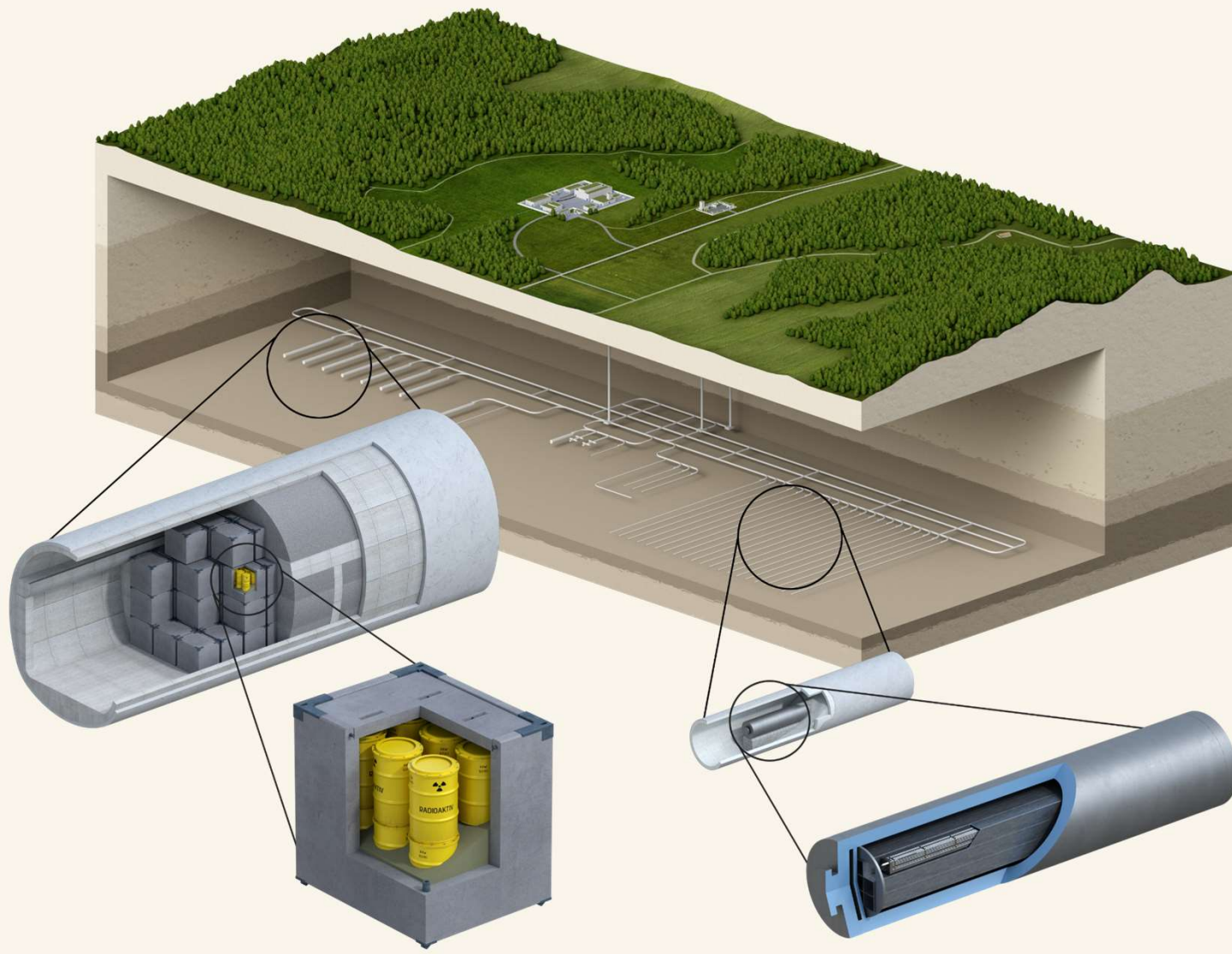

# Konzept HAA

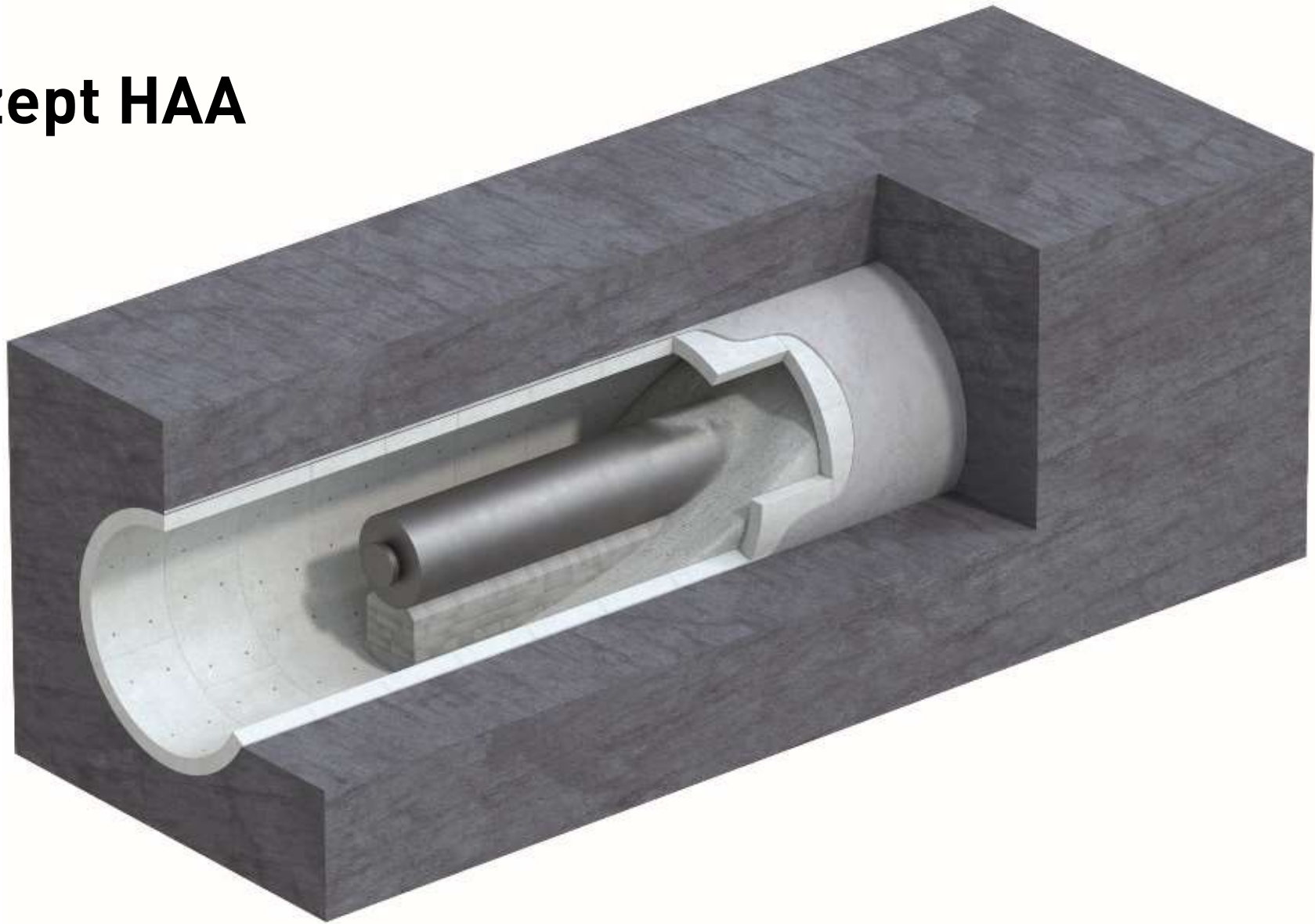



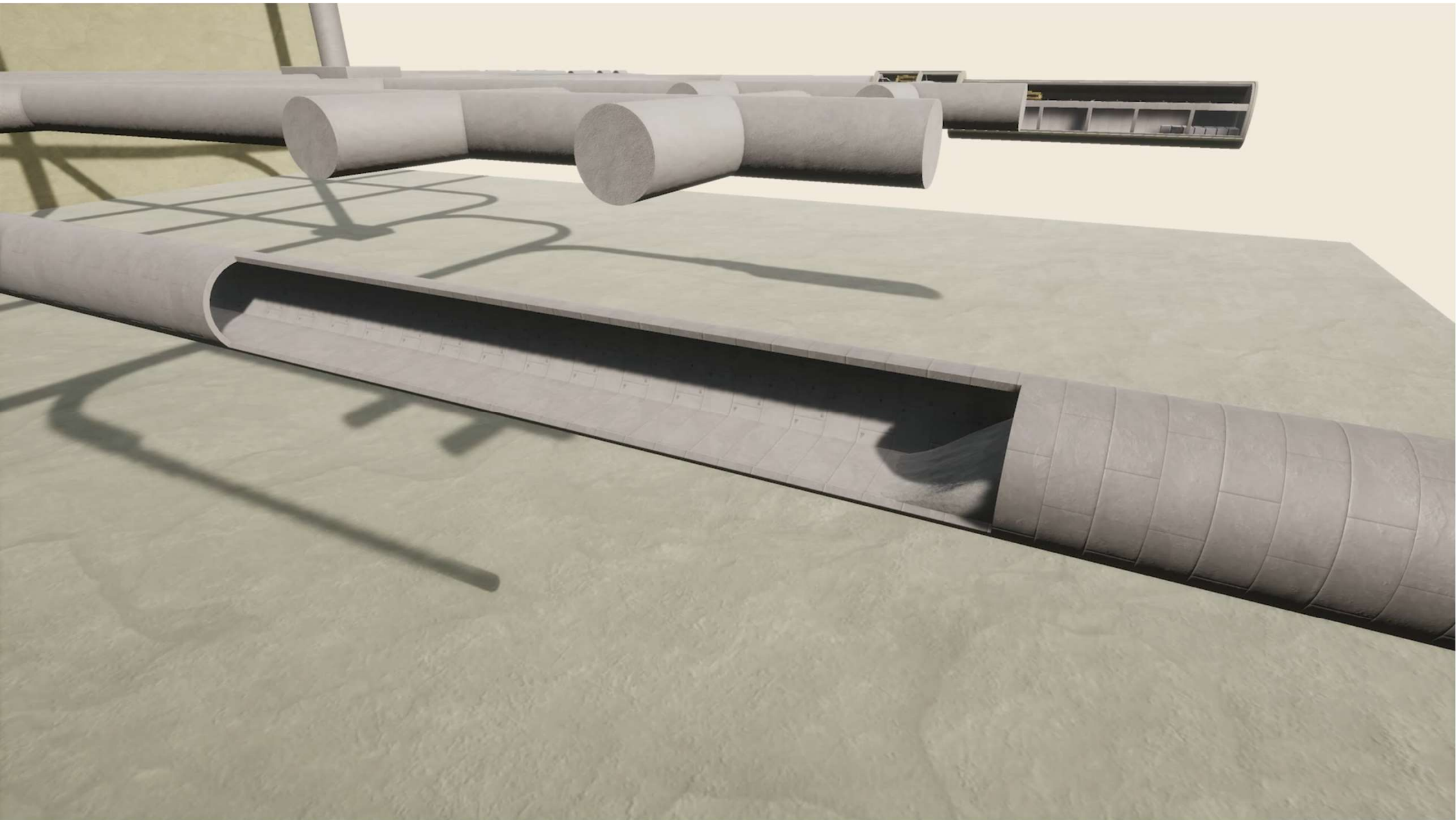

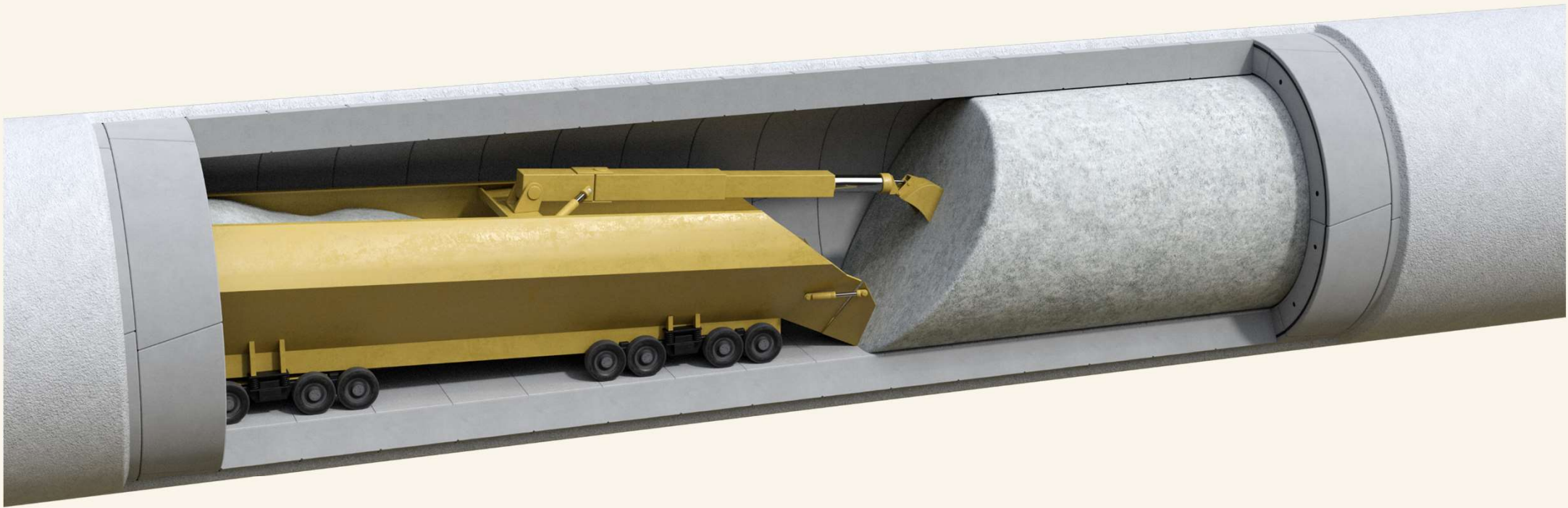



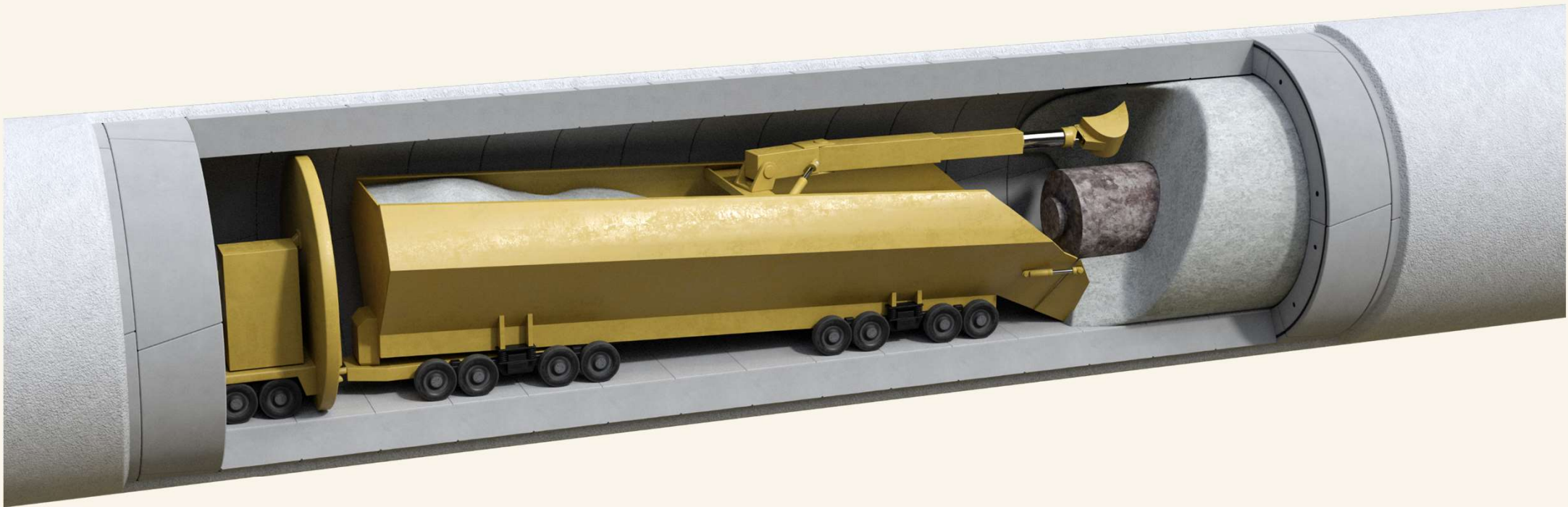

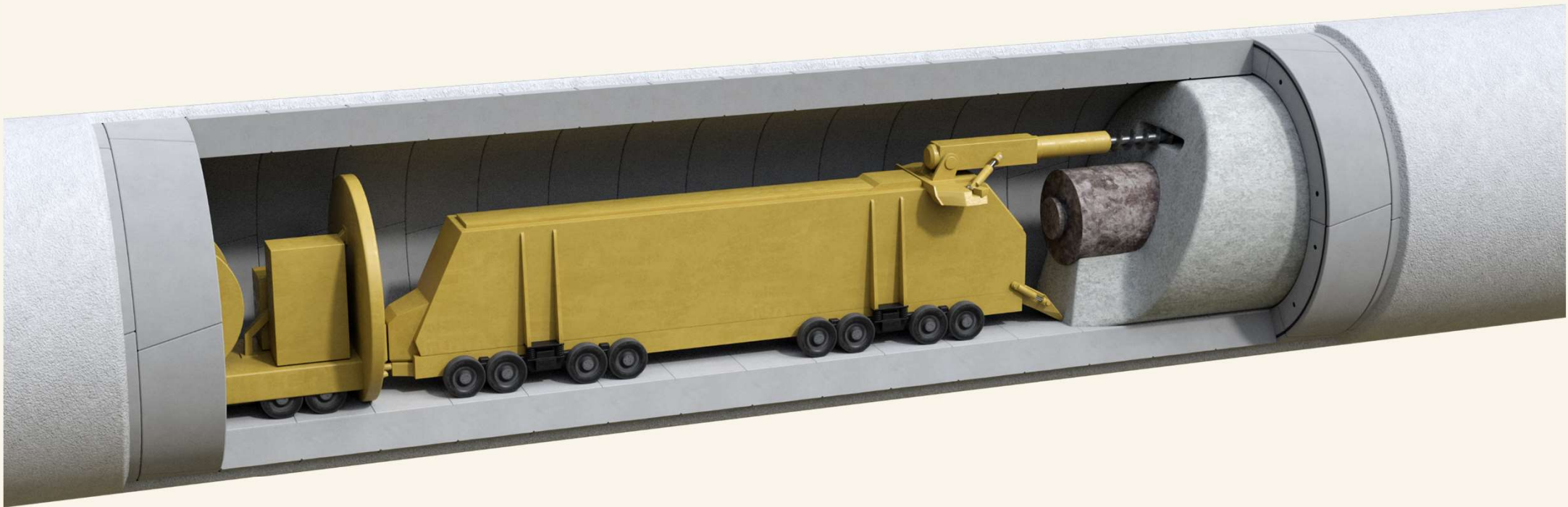



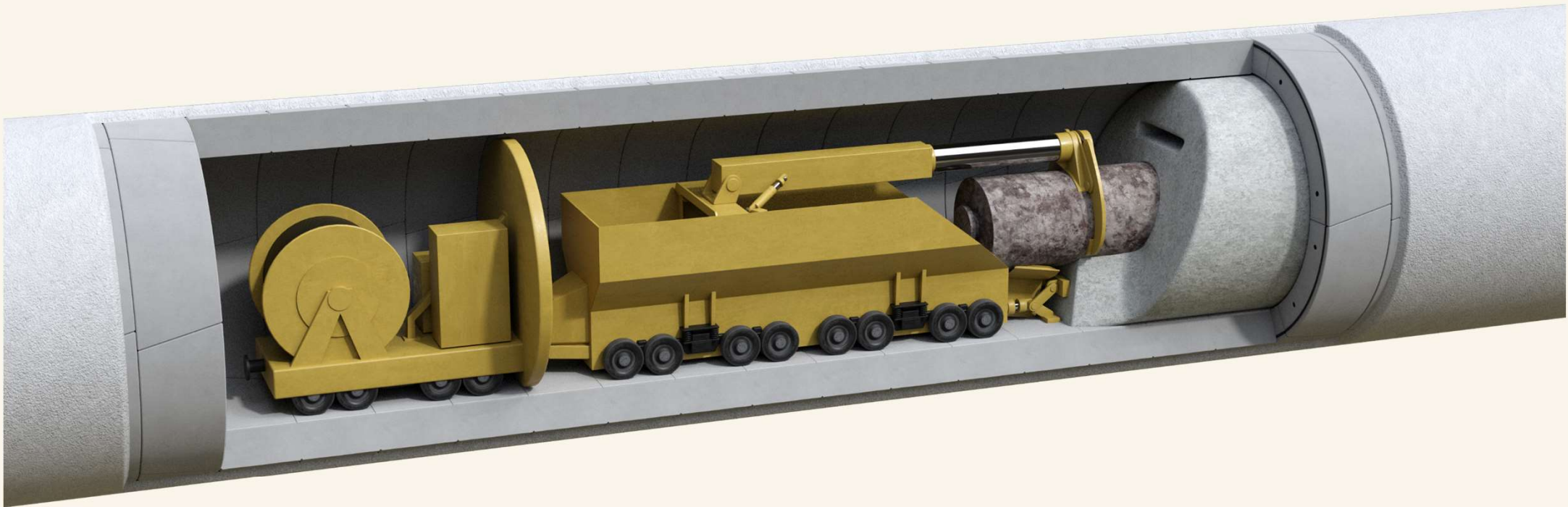

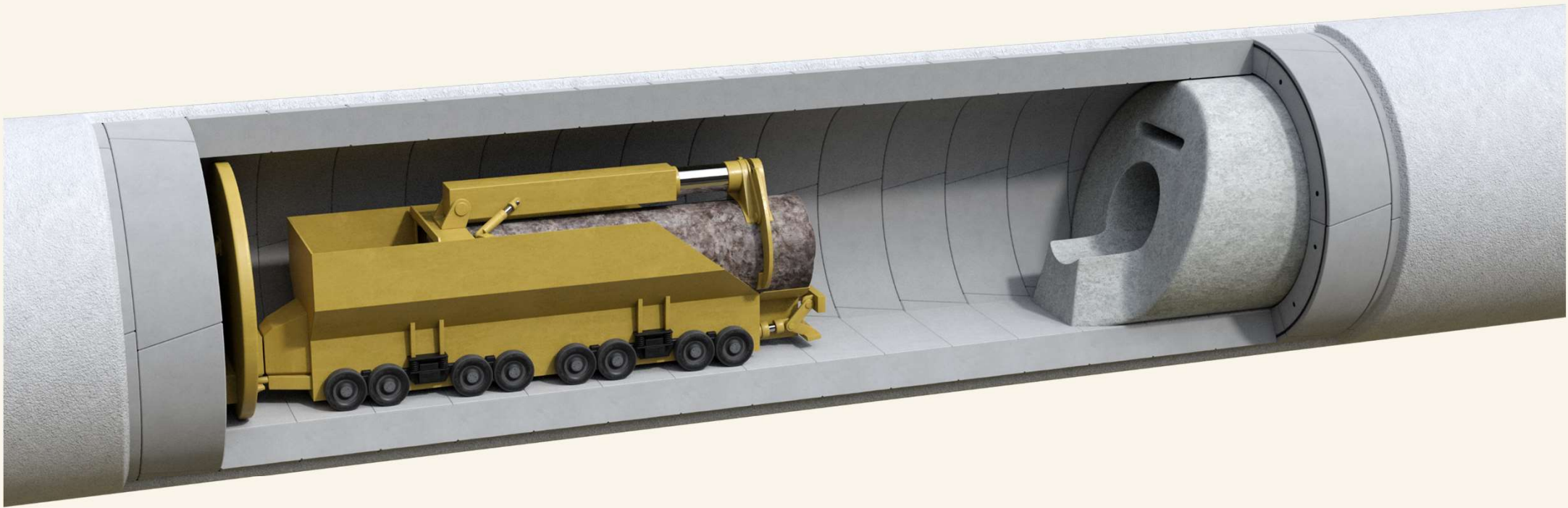



# RÜCKHOLUNGSTECHNOLOGIE «aus dem Katalog»



MineMaster, Face Master 2.1:  
Dimensionen (L-B-H): 10.2 x 1.35 x 2.1 m



Sandvik TS490L:  
Dimensionen (L-B-H): 10.1 x 3.3 x 1.65 m  
Nutzlast: 40 t

# KÜHLUNG

## Arbeitsbericht NAB 22-31

### Lüftungs- und Kühlungskonzept geologisches Tiefenlager

September 2022

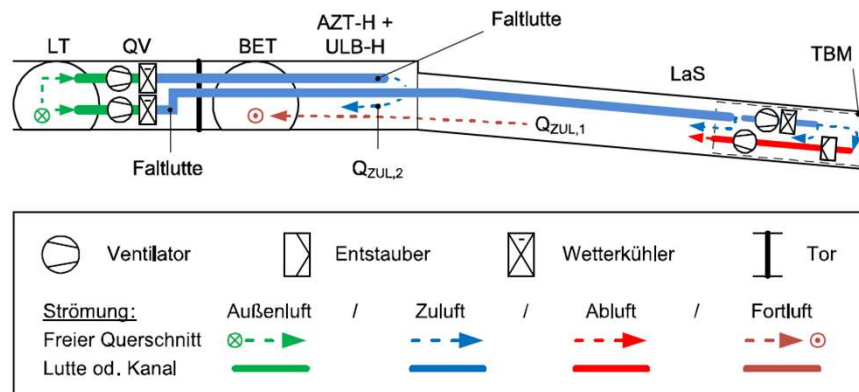
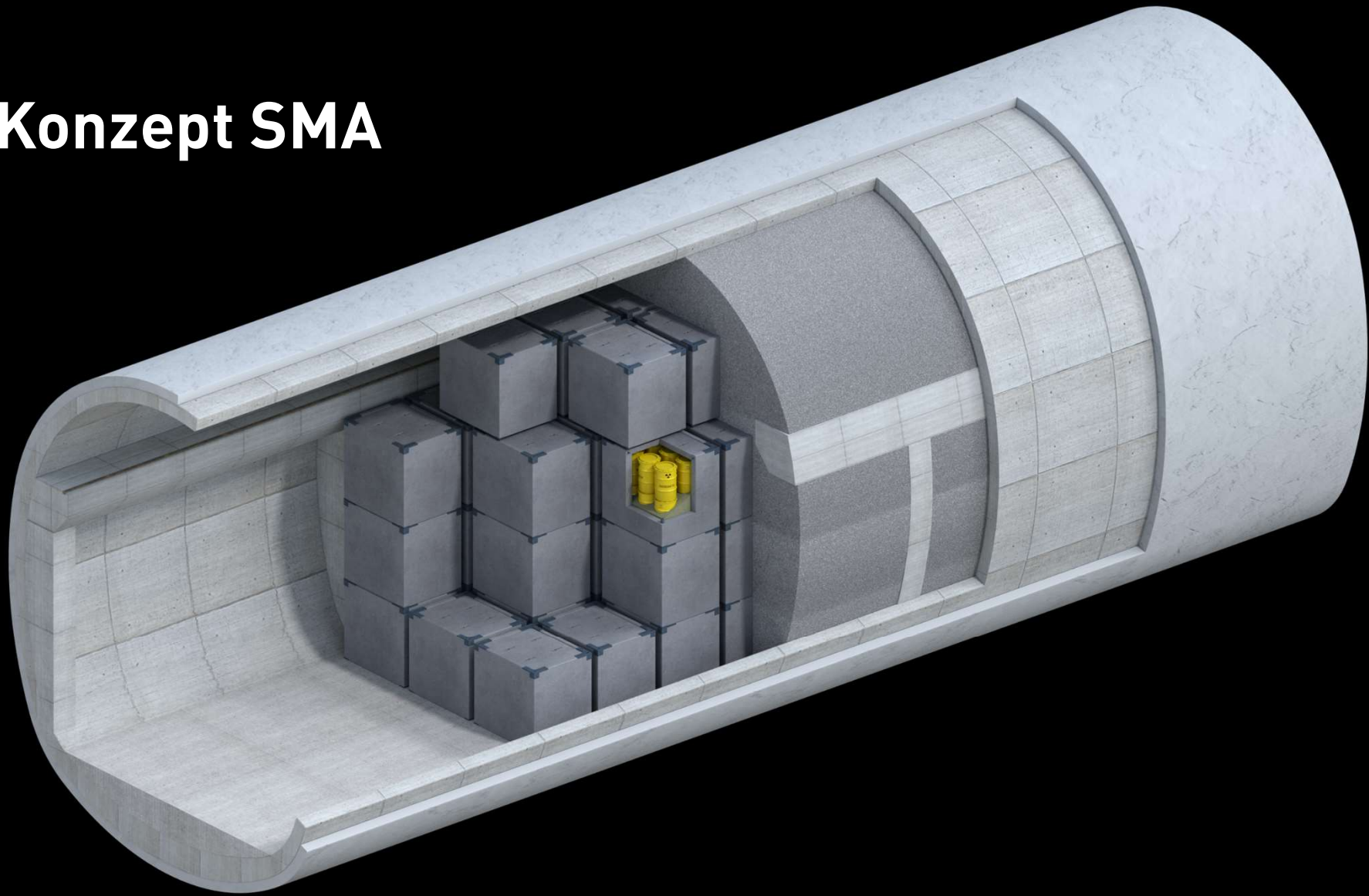
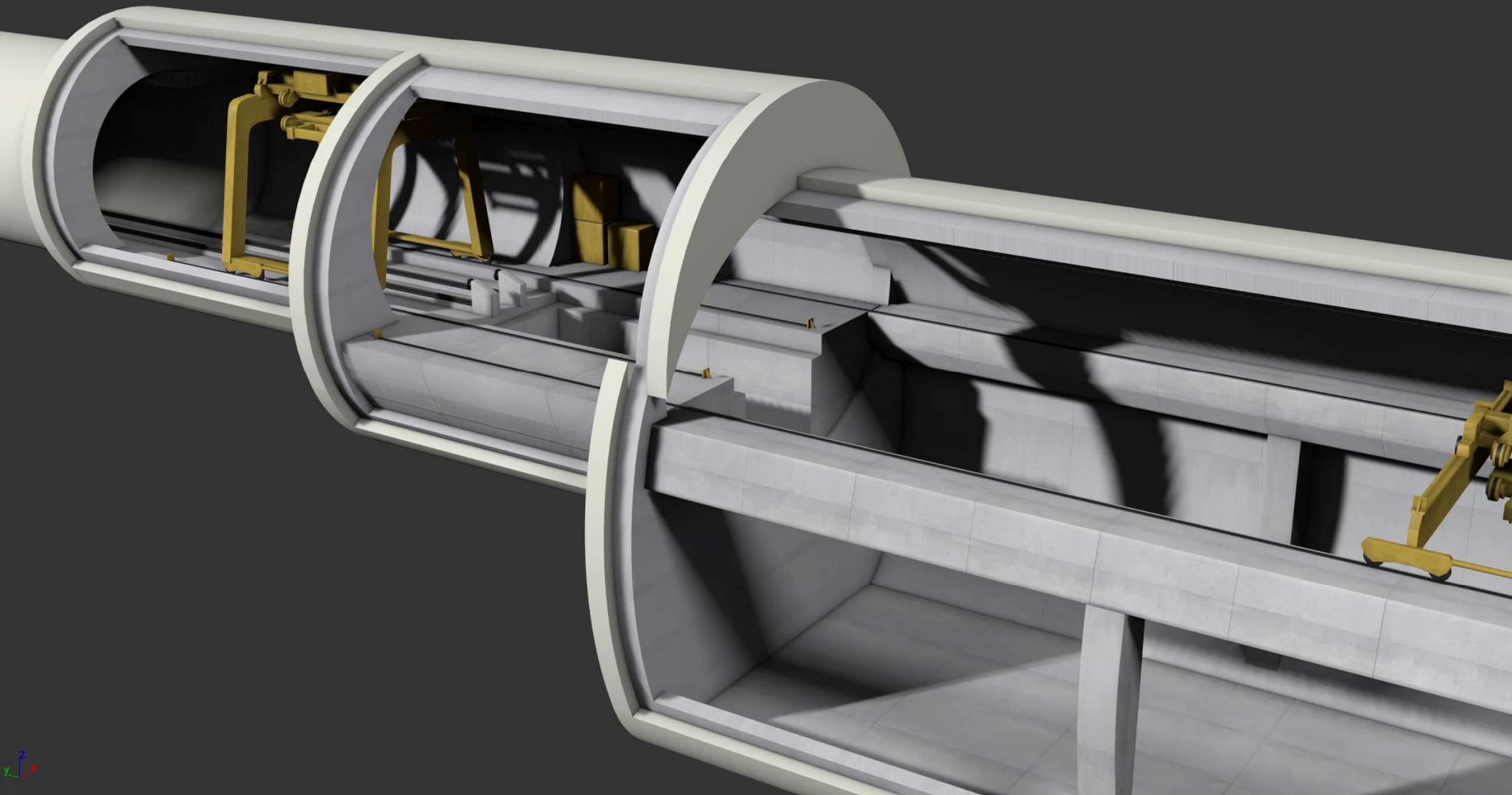

Fig. 3-3: Lüftungs- und Kühlungskonzept eines TBM-Vortriebs für den Bau eines HAA-Lagerstollens



# Konzept SMA







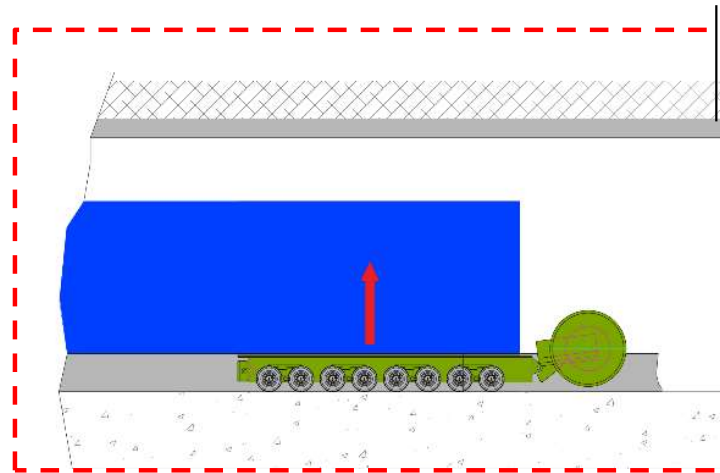
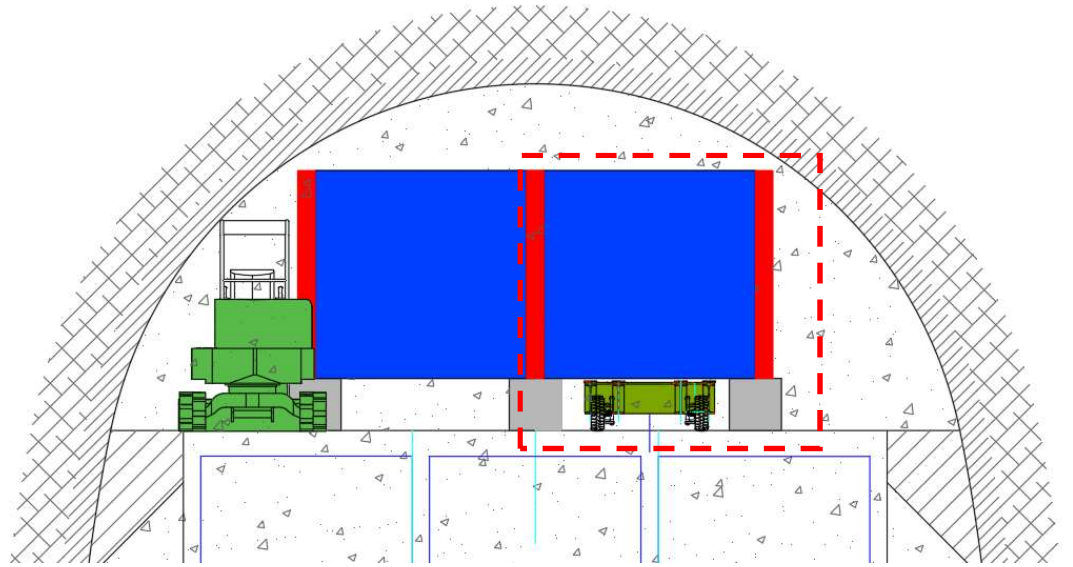
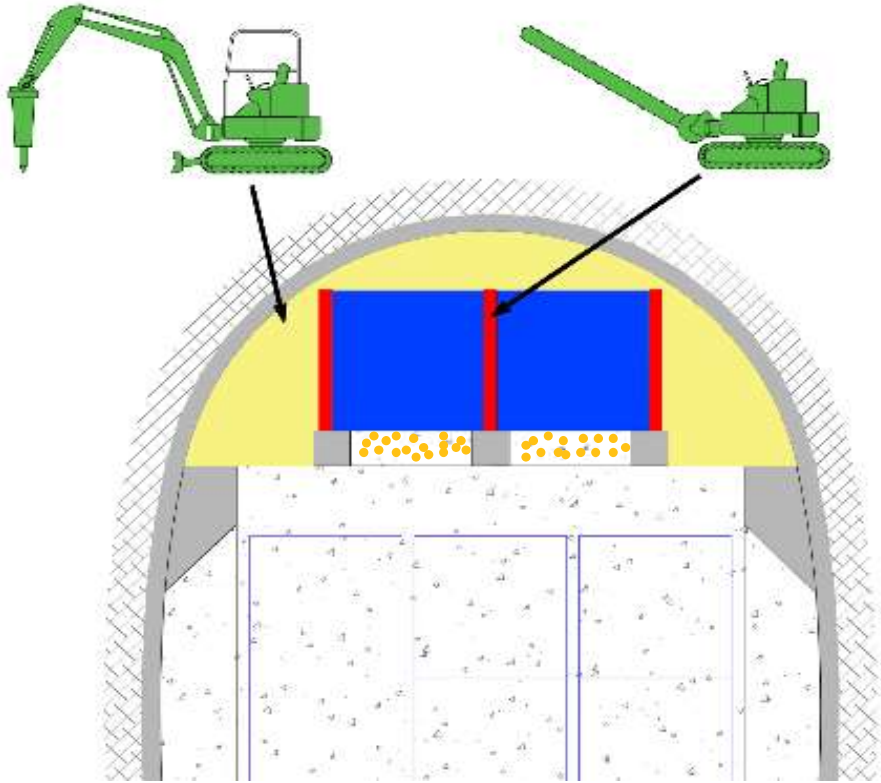

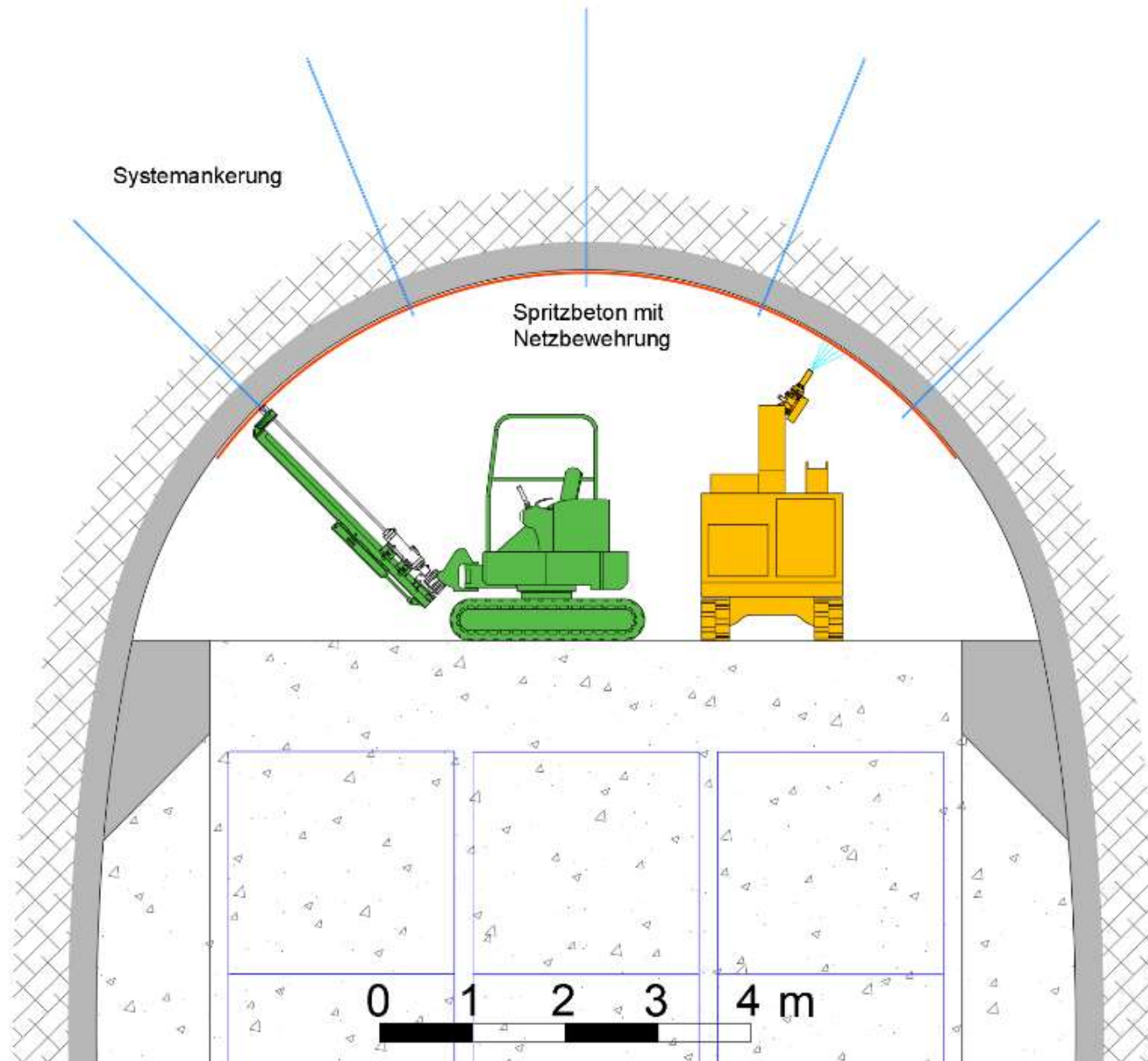

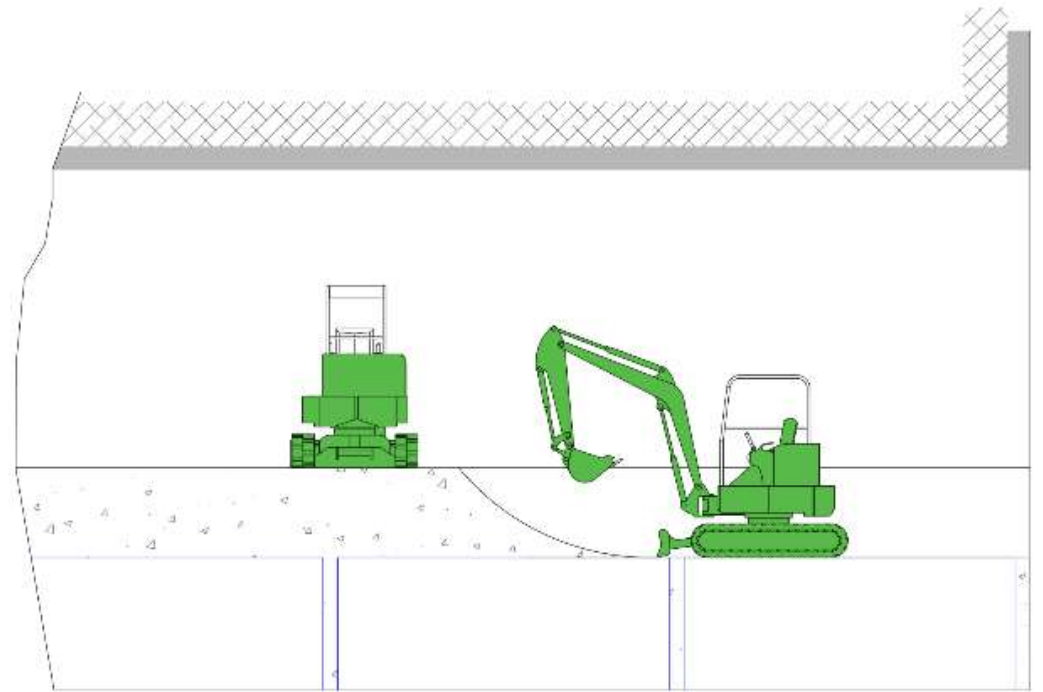
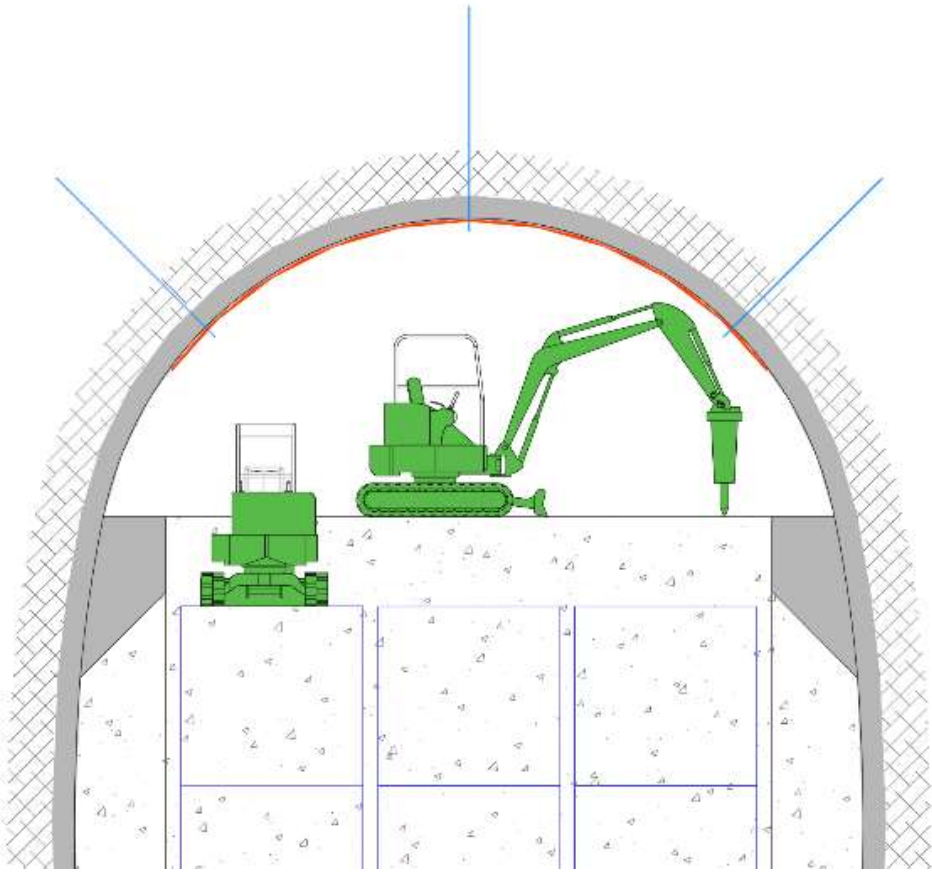



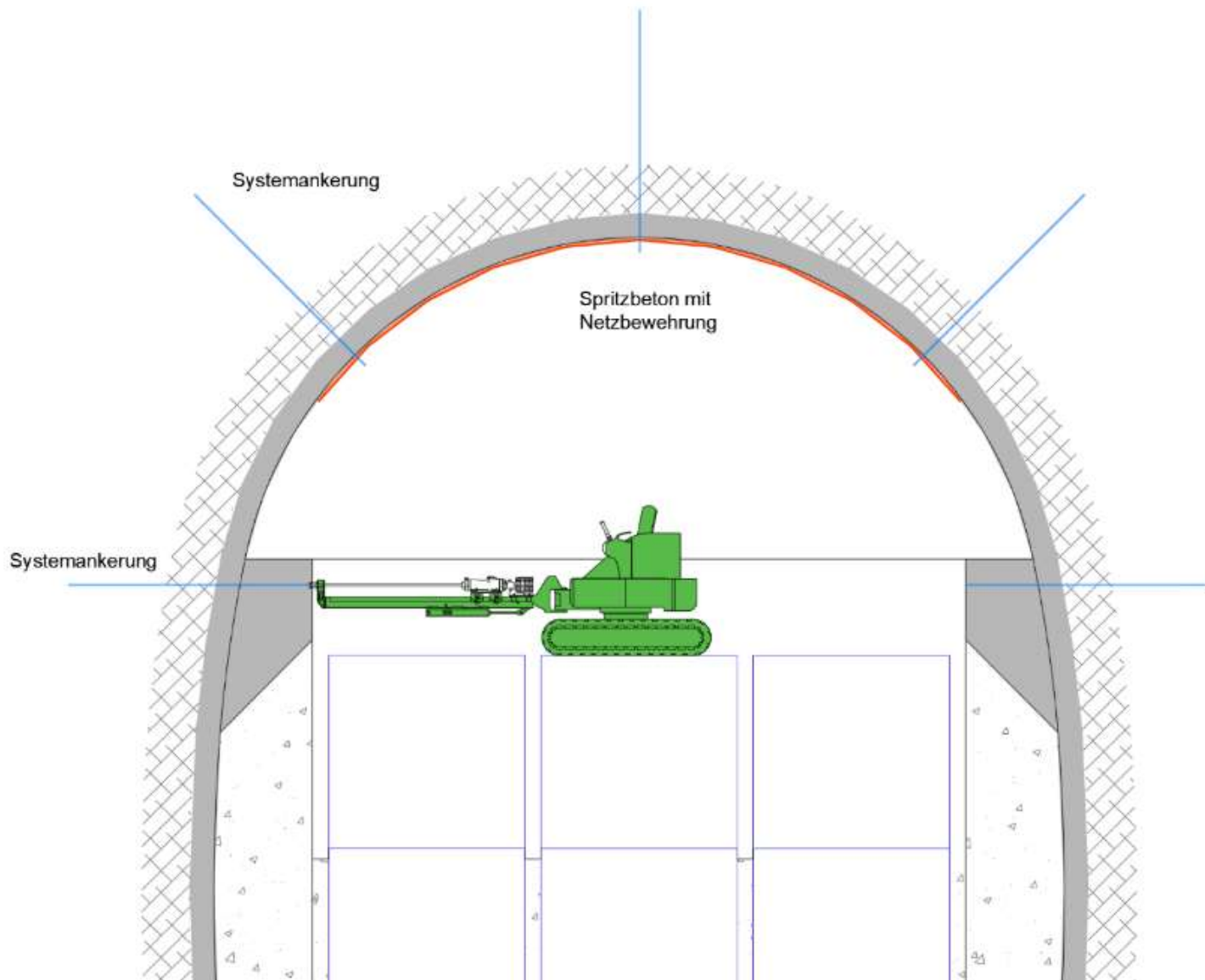

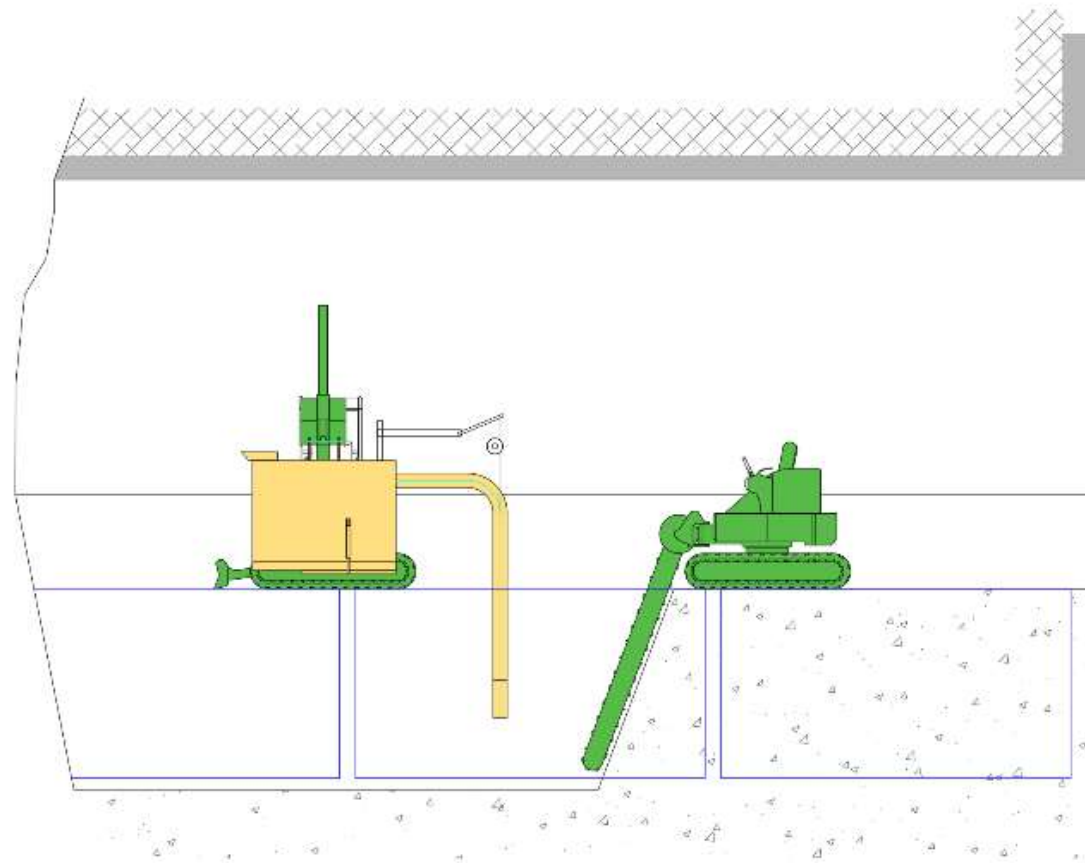
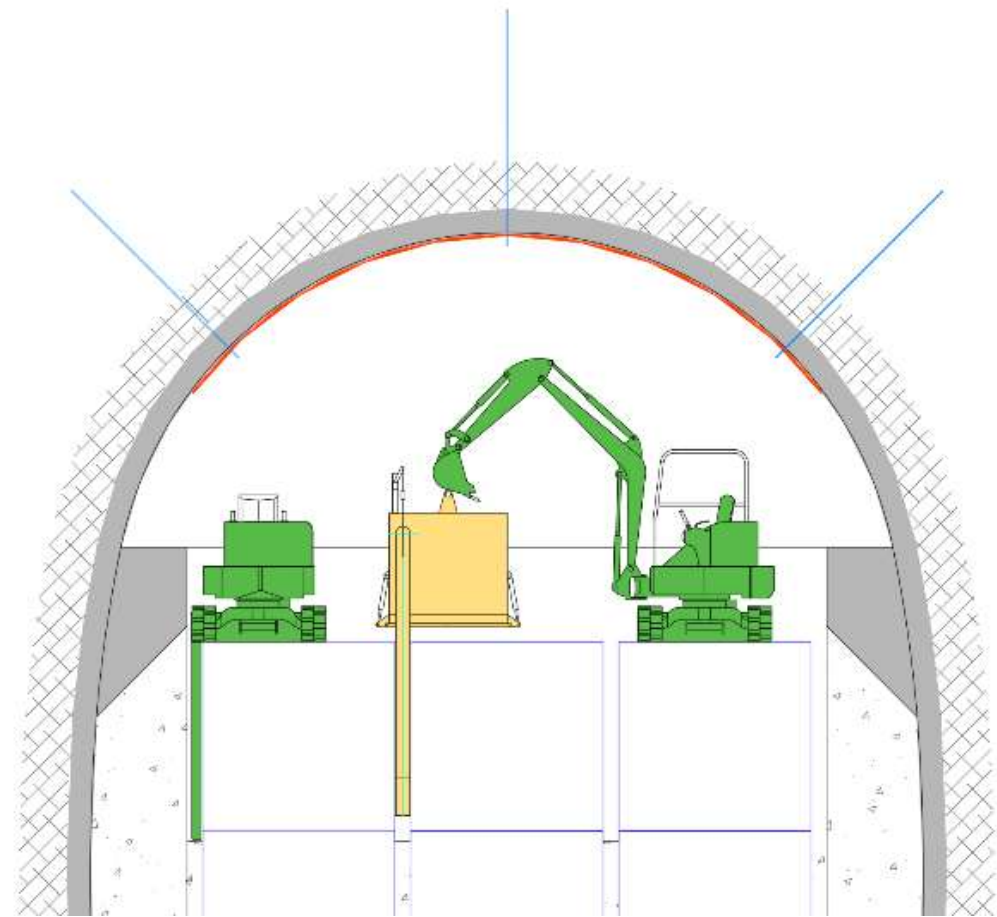

Kaverne

Übergangsstrecke

Zugangstunnel

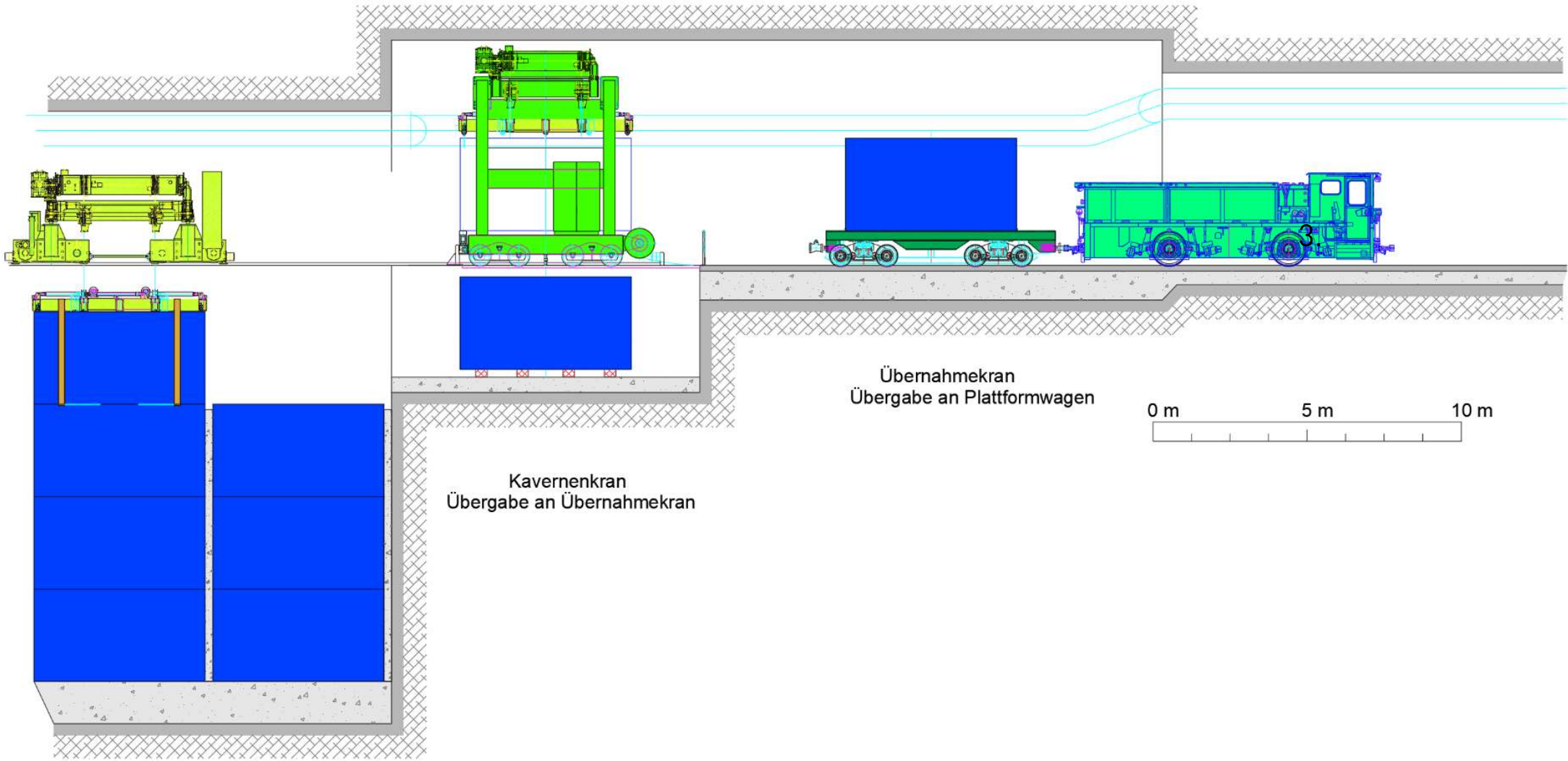

Übernahmekran  
Übergabe an Plattformwagen

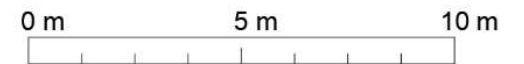

Kavernenkrane  
Übergabe an Übernahmekran

Kavernenkrane



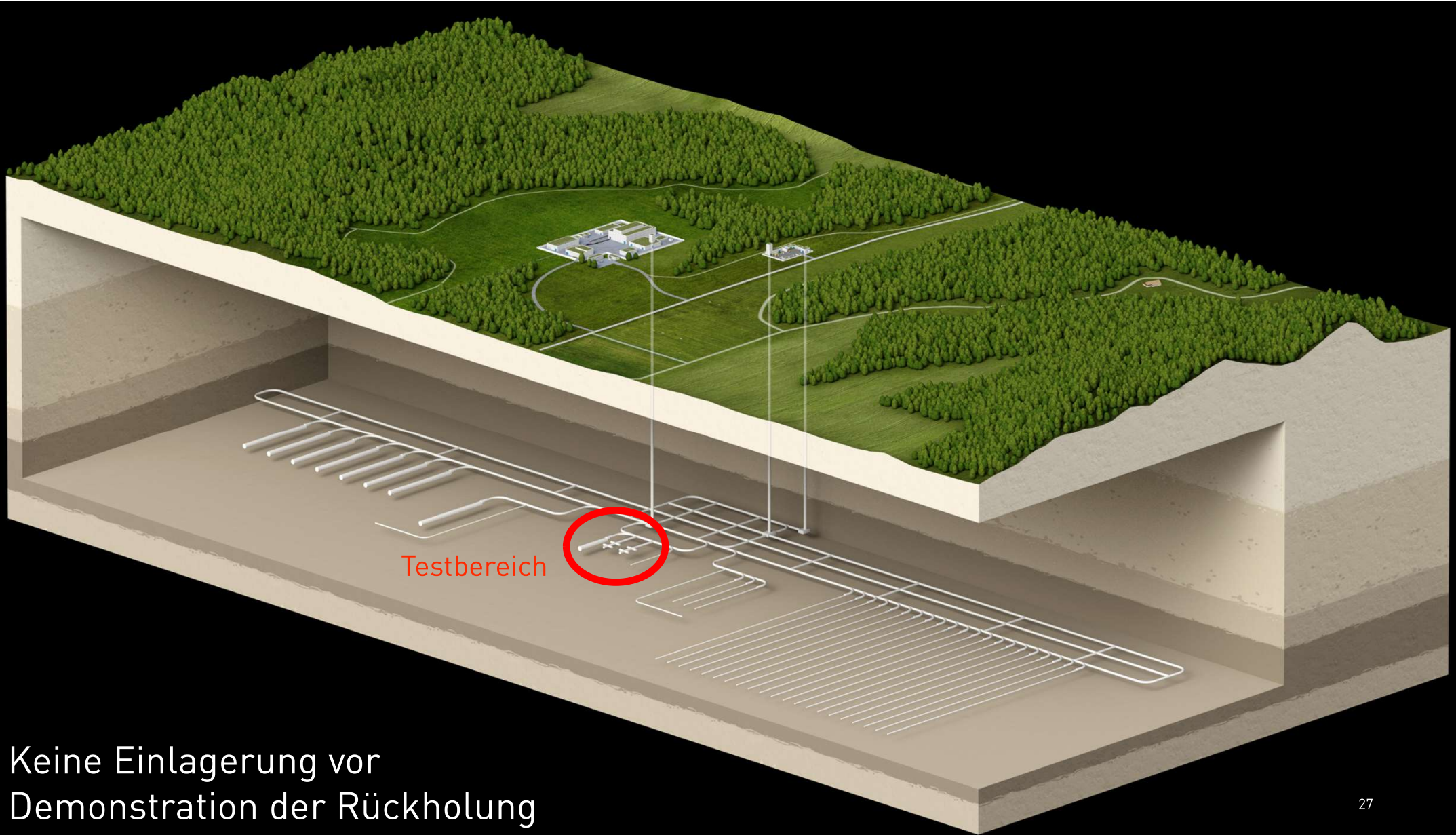

Keine Einlagerung vor  
Demonstration der Rückholung

# FELSLABOR MONT TERRI → PIOTLAGER TIEFENLAGER

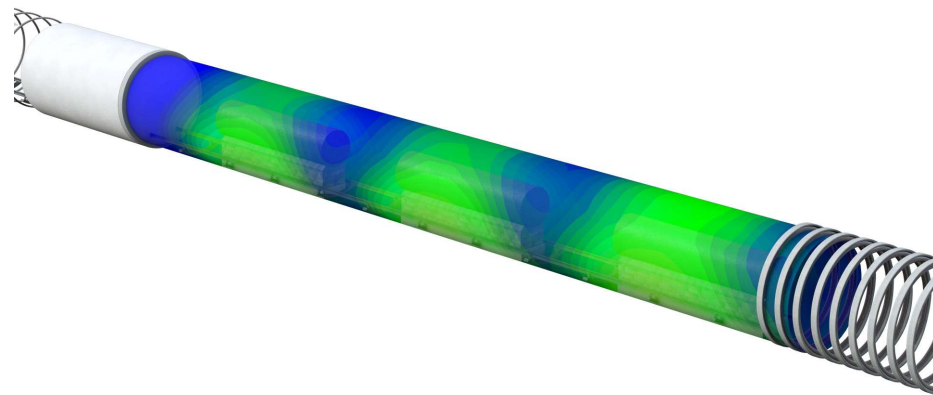
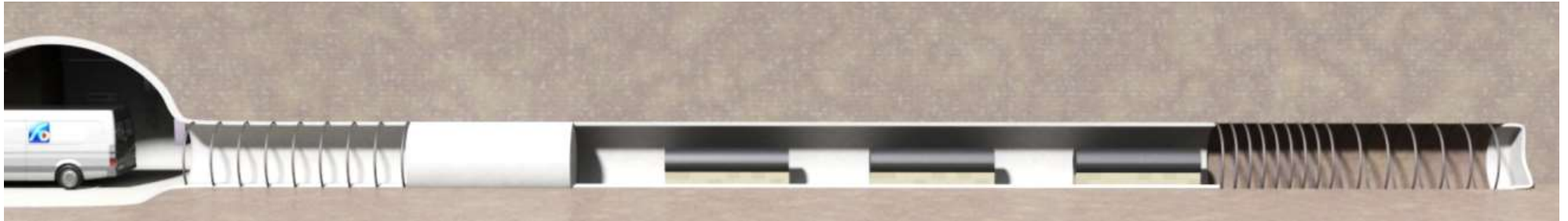

2015

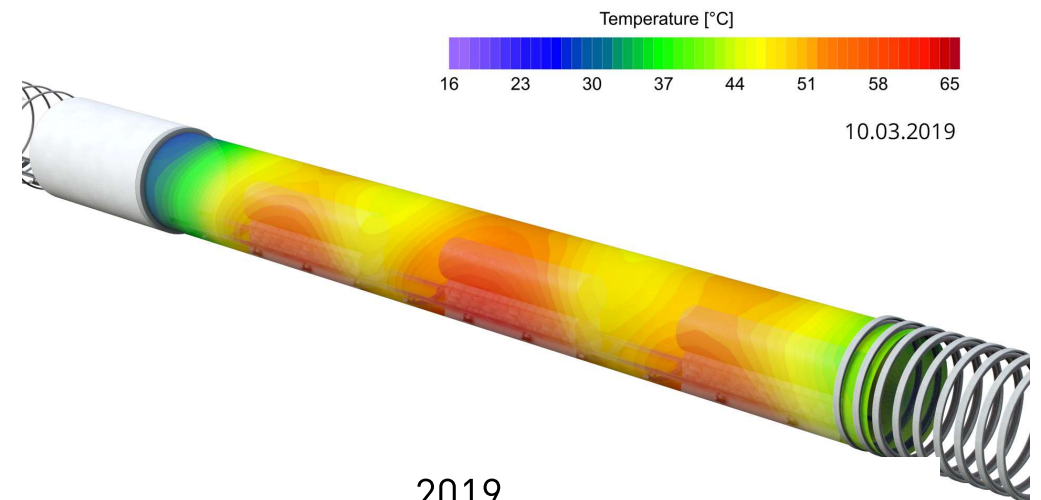

2019



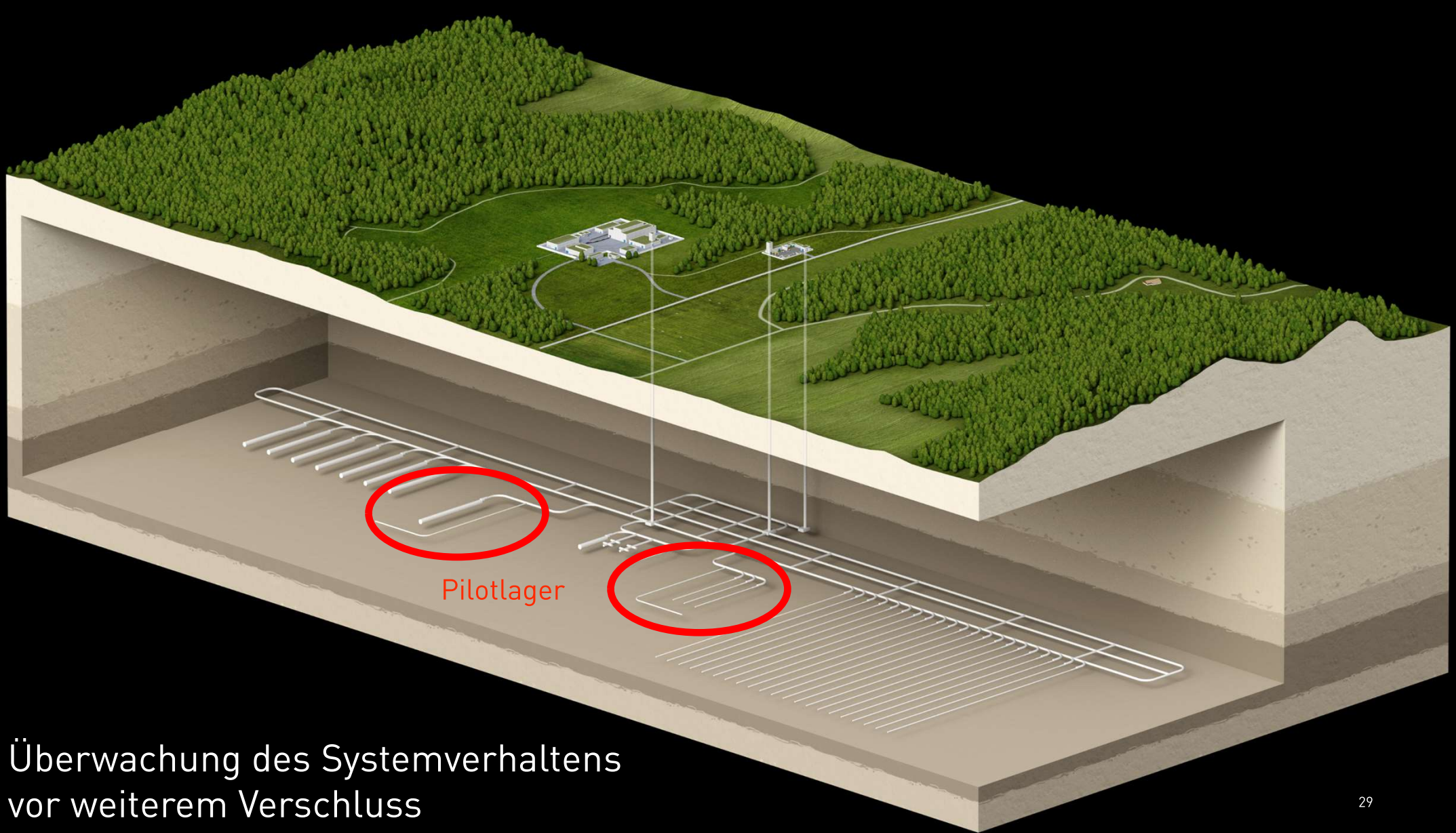

Überwachung des Systemverhaltens  
vor weiterem Verschluss





DANKE FÜR IHRE  
AUFMERKSAMKEIT

**nagra.**